

Bag vacuum cleaner

**orava**

# Volcano 1

## Instruction manual

EN



CE

Volcano 1

## The intended use of the device

Device - Household vacuum cleaner, powered by the floor, floor  
- is designed exclusively for the dry removal of dust particles and common household impurities (eg fibers, hair, hair, etc.) of dry surfaces to the extent determined by technical and operating parameters and functions, safety and user instructions and external influences of the operating environment. ORAVA electrical appliances are manufactured according to current state of the engineering and recognized safety-technical rules. Nevertheless, incorrect or improper use, or use contrary to designation may result in the risk of injury or endanger the life of the user or third person, damage to the device and other material values.

### 1. GENERAL SAFETY INSTRUCTIONS AND WARNINGS

- This document contains important safety instructions and warnings for safe, correct and economical operation of the electrical equipment. Its compliance helps the user avoid risks, increase reliability and product life.
- In this document, the general term product is used in text parts such as: electrical equipment - any device used for the production, conversion, transmission, distribution or use of electricity.
- From the point of view of the purpose of using electricity, the concept of electrical equipment in the strict sense of the word will include the following categories:
  - household electric appliances,
  - information and communication equipment,
  - consumer electronics,
  - lighting equipment,
  - electrical and electronic tools,
  - toys and equipment for sporting and recreational purposes,
  - medical devices (aids),
  - monitoring and control devices,
  - vending machines.

#### 1.1 General safety instructions

- Before operating the unit, we recommend that you carefully read the instruction manual and operate the equipment in accordance with the instructions!
- The safety instructions and warnings in this manual do not cover all the possible conditions and situations that may arise when using the device. The user must understand that a factor that cannot be incorporated into any of the products is personal responsibility and caution. These factors must therefore be ensured by users serving this device.
- Failure to follow the safety instructions and warnings is forbidden by the manufacturer for any damage to health or property!
- Keep the instruction manual as close to the device as possible throughout its service life. Always keep the instruction manual together with the appliance for future use and use by new users.
- Use the appliance only for the intended purpose and in the manner specified by the manufacturer.
- The appliance is intended for home and similar indoor use without special focus.

- This appliance is intended, in addition to domestic use, for the following uses:
  - in shops, offices and other similar work environments;
  - in economic buildings;
  - in hotels, motels and other residential environments;
  - in bed and breakfast establishments.
- It is not a professional device for commercial use.
- Do not change the technical parameters and features of the device by unauthorized modification or modification of any part of the device.
- The manufacturer is not responsible for damages caused during transportation, misuse, damage or destruction of the equipment due to adverse weather conditions.

## 1.2 Safety of the operating environment

- Do not use the device in an industrial environment or outside environment!
- Do not expose the appliance to:
  - sources of excessive heat or open flame,
  - dripping or splashing water,
  - vibration and excessive mechanical stress,
  - insects, animals and plants,
  - aggressive and chemical substances.
- The operating environment of the device must always be in accordance with the basic characteristics set out.
- Features of the operating environment:
  1. Ambient temperature:  $+5 \div +40$  ° C
  2. Humidity:  $5 \div 85\%$
  3. Altitude:  $\leq 2\ 000$  m
  4. Occurrence of water: intermittent condensation of water or occurrence of water vapor
  5. Occurrence of foreign bodies: quantity and type of dust are insignificant
  6. Protection degree: min. IP20 (device protected from touching dangerous parts by hand and non-waterproof)
- This degree of protection is not indicated on the product and on the technical parameters in the operating instructions.
- If the protection class of the product is different from IPX0, this information is then displayed on the label of the appliance or in the technical data of the operating instructions.
- Other characteristics of the domestic operating environment (mechanical stress - vibrations and vibrations, occurrence of plant, animals, weather effects ...) are negligible in terms of effect on the correct and safe use of electrical equipment.

### 1.3 Electrical safety

- Before connecting the appliance to the power supply for the first time, make sure that the voltage on the appliance label corresponds to that of the household electrical outlet.
- The electric appliance is designed to power from 1 / N / PE ~ 230 V 50 Hz.
- The electrical safety of the appliance is guaranteed only if it is properly connected to the mains.
- Electrical protection class I equipment is equipped with a protection against electric shock by means of protective earthing of inanimate parts, which can become dangerous when the device is malfunctioning. Always connect such devices to properly installed mains sockets that are equipped with earthing conductors and have a properly grounded earthing conductor.  
All electrical equipment is equipped with a three-wire power supply.
- Class II electrical equipment is protected against electric shock by double insulation or by enhanced insulation of hazardous live electrical parts. Device of protection class II it must not be equipped with means to connect protective earthing.  
All electrical equipment is equipped with two-wire power supply.
- Class III electrical equipment is a device that is powered by a small safe voltage source (battery or accumulator) and does not present any danger to the user from electrical shock.
- In order to provide increased safety against the risk of electric shock due to the use of electrical appliances by laypersons, it is recommended to install the power supply circuit for sockets with a rated current not exceeding 20 A RCD with a rated operating current not exceeding 30 mA.  
To ensure the safety and correctness of the electrical installation, consult a qualified electrician.
- Only use a power cord with a plug (mains lead) supplied with the device and compatible with a wall socket. Using another cable may result in fire or electric shock.
- Always connect an electrical appliance to an easily accessible mains socket. In the event of an operating fault, the appliance must be switched off as soon as possible and disconnected from mains supply.
- The power cord and mains plug must always be easily accessible for safe disconnection of the electrical appliance from the power supply.
- Do not pull off the power cord by pulling the cable. Disconnect the power cord by pulling the plug behind the power cord plug.
- If you use an extension cord, make sure that the total rated power of all devices connected to the extension cord does not exceed the max. current load on the extension cable.
- If you need to use an extension cord or power supply block, make sure that the extension cord or power pack is plugged into a power socket, and not to another extension cord or power supply. The extension power cord or power supply block must be designed for grounded electrical plugs and connected to a properly grounded electrical socket.
- The power plug of the appliance must be compatible with the mains socket. Never use any adapters or modify the socket in any other way. Do not use inappropriate or damaged drawers!
- To avoid electrical shock, plug the power cables into properly grounded electrical sockets. If the device is equipped with a 3-pole plug, do not use adapters that do not have a grounding element or remove the grounding element from the plug or adapter.

- Do not bend, crush or otherwise expose the power cord of the appliance to mechanical stress or external heat sources. Damage to the power cord may result in electric shock.
- When the power cord is damaged, disconnect the appliance from the mains and do not use it again.
- If the power cord is damaged, it must be replaced by the manufacturer, its service department or a similarly qualified person to avoid the risk of electric shock.
- Regularly check and maintain the electrical appliance as well as the power cord and power socket. Disconnect the power plug regularly and clean it if necessary. Pollution by dust or other substances may cause disruption of the insulating state and consequently fire.
- Do not expose the appliance to water or moisture. The ingress of water into the appliance increases the risk of electric shock.  
If the power cord is wet or the water has penetrated the water, disconnect it immediately from the mains. If the appliance is plugged into a mains socket and if possible, turn off the power circuit before attempting unplug the power. If you are pulling wet wires from a live power source, be very careful.
- If the electrical equipment is installed (connecting) the protective covers are dismantled, the electrical parts must not be accessible to the user when the installation is finished.

#### **1.4 Safety of persons**

- This appliance is intended for use and operation by persons without electrotechnical qualification - lay people, according to the instructions specified by the manufacturer.
- Device operation includes activities such as switching on and off, user manipulation and setting of operating parameters, visual or auditory inspection of the equipment, and user cleaning and maintenance.
- This appliance can be used by children under the age of 8 and persons with reduced physical, sensory or mental capabilities or lack of experience or knowledge when supervised or instructed to use the appliance safely and understand the dangers involved.
- Children may not play with the appliance.
- Cleaning and maintenance for users may not be performed by children unattended.
- Always keep the appliance out of reach of children during use and operation. Be sure to unplug the appliance even for a freely accessible power cord.
- Always be careful when operating the electric appliance! Do not use an electric appliance if you are overly tired, under the influence of medication or narcotic drugs that reduce attention and focus.
- Inattention during operation may result in serious injury.

## 1.5 Cleaning, maintenance and repairs

- Observe the normal user cleaning and maintenance of the appliance in the recommended way. Do not use solvents or harsh cleaners for cleaning. Pollution and visible stains from finger contact, respectively. The hands can be cleaned using detergent detergents specially designed to clean household appliances.
- If you do not use the appliance, clean it or disconnect the appliance from the power supply when the appliance is faulty.
- Electrical appliances that are cleaned after use and are not intended to be completely or partly immersed in water or other liquid, protect against the effects of dripping and / or splashing water and before immersion.
- Electric household appliances, like all other technical devices, are subject to the surrounding environment and natural wear. Since the legal framework of regular maintenance is not laid down for lay-in electrical household appliances, the manufacturer recommends that the user have the appliance checked and cleaned at least once a year by a specialist workshop.
- By doing so, it is possible to achieve safety, operational reliability and increased service life.
- Do not disassemble the electric appliance! The appliance works with a dangerous voltage. For this reason, always switch off the appliance and disconnect it from the mains supply during user maintenance. In the event of a fault, please have the repair serviced by an authorized service center.
- Before calling a service:
  1. Verify that you are unable to remedy the malfunction yourself according to the procedure described in the chapter „Remedy of operating faults“.
  2. Turn the appliance off and on to make sure the fault reappears.
  3. If the malfunction of the appliance still persists after these operations, call the nearest specialist service center.
- Never repair the electric appliance yourself!
- Unauthorized, unqualified and improper use of an electric appliance may result in electric shock or other serious injury.
- Only carry out the warranty or post-warranty repair of an electrical appliance to an authorized qualified person (\*).

(\*) Competent qualified expert: the sales department of the manufacturer or importer or the person qualified and authorized to carry out this type of activity with the ability to avoid all risks.

## 2. Special Safety Instructions. Read carefully!

- Electrical equipment is designed and manufactured in such a way as to allow for safe operation and use by persons without a professional qualification. Despite all measures taken by the manufacturer for safe use, handling and use, they carry with them some residual risks and associated potential hazards.
- The following symbols and their meanings have been used on the device and in the accompanying documentation to warn of possible hazards:



This symbol alerts users that the device is operating a dangerous electrical voltage. Do not remove protective covers on the device. Failure to observe the safety instructions during use and operation of the device may result in:

Danger of electric shock!

Danger of serious injury or life threatening!



This symbol alerts users to the following: Risk of serious injury or life threatening when not following the safety instructions when using and operating the unit!

Danger of damage to equipment or other damage to property!



This symbol means that the product is made with a double insulation between hazardous live parts (parts with dangerous voltage from the mains) and parts that are accessible in normal use.

### Transportation/Transfer

- When transporting and using, for example, of the transport carriage be careful when moving, to avoid overturning the device.
- Transport / carry the equipment only after thorough inspection of the space and the routes, which must be unobstructed.
- Transfer the device only after disconnecting the AC power.
- The appliance is intended for floor laying when used.
- Always carry the appliance by grasping the handle. Do not carry the appliance behind the suction hose and do not move or hover by the power cord.

There is a risk of serious injury or life threatening!

There is a risk of damage to the device!

### Unpacking/Packaging

- Unpack the equipment and accessories before putting it into service and remove all parts of packaging material, labels and labels. Store the packaging in a safe place, especially out of the reach of children and unaccompanied persons, or dispose of them safely.

There is a risk of serious injury!

Risk of suffocation!

## **Check/Commissioning**

- Clean the machine before commissioning as described in the “ Commissioning “ or “Cleaning” section.
- Never clean the device (body with electrical parts) and the power cord with the plug in a way that could cause the liquid to flow into the device.
- Clean these parts with a damp cloth only and wipe dry or let it dry.
- Only clean the appliance if it is switched off and disconnected from the mains.
- We recommend performing both initial and subsequent regular machine inspections.
- Only use the appliance with the required filters and accessories!
- Never use the appliance if it is incomplete, damaged, or if parts or accessories (eg due to fall) have been damaged during use.  
There is a risk of electric shock!  
There is a risk of serious injury!

## **Operation/Supervision**

### **Recommendation:**

- It is recommended to use personal health care products such as eyeglasses and respiratory gloves when vacuuming fine dust particles.

### **Warning!**

- Do not use the appliance to vacuum materials, substances, dust and other impurities that are hazardous to human health, animal health or the environment! It is, for example, dust particles and asbestos dust, nanomaterials and the like.

### **Warning!**

- Do not use the appliance to drain fluids, such as:  
- liquid substances, foodstuffs, and the like.
- Do not use the appliance to vacuum grease and grease, such as:  
- grease, oil, petroleum products and the like.
- Do not use the appliance to vacuum technical materials such as:  
- sharp glass and metal particles, pieces and dust particles of building materials and the like.
- Do not use the appliance to vacuum the chemical and toxic materials and their particles, such as:  
- lead, mercury, chrome, chlorine and ammonia cleaners, bleaches, and the like.
- Do not use the appliance to vacuum easily flammable, or explosive materials and their particles, such as:  
- solid and / or liquid ignitors, petrol, diluents and the like.
- Do not use the appliance in areas where vapors of flammable or explosive materials and substances may occur.
- Do not use the appliance to vacuum hot objects, materials and their particles, such as:  
- Cigars or cigarettes and cigarette ash, coal and coal ash, matches, etc.
- For orientation - it is generally about objects, materials and substances with a temperature above 40 °C.



- At temperatures of materials and substances above 40 °C (100 °F) there is a risk of fire.
- Cold ash is ash cooled for a long time, which is in a state where it no longer contains particles of carbon in its interior. Such ash does not burn any more recognizable heat anymore.  
Do not use the appliance for vacuuming:
  - saddles and the like.
- Do not expose wet / damp surfaces / floors and floor coverings!  
Moisture penetration into the electrical parts of the device may cause damage to the device or electrical shock.

### **Warning!**

- Do not use the appliance to vacuum fabrics and clothing directly on persons!
- Do not use the device to vacuum animal hair and hair directly on pets!
- Do not expose yourself (parts of the body, faces, hair, loose parts, etc.) to other people or animals by suction (vacuum) from the suction line or accessories attachments when using the device (if the device is in operation).  
There is a risk of serious injury!
- Always keep your device under control during use and operation!
- This device is not intended to be operated by a programmer, an external time switch or a remote control, because there is a risk of fire when covered or incorrectly positioned.
- Do not use the device near materials and objects such as, for example, hangings, curtains, decorative fabrics, and the like.
- Do not cover the appliance in part. There is a danger of fire!
- When vacuuming some surfaces and using the device under low humidity conditions, the device may be a source of static electricity. It is a normal phenomenon that does not damage the device and is not its failure. When creating such a phenomenon, it is recommended:
  - discharging the device by touching a tube of metal objects,
  - increase of air humidity in the room of the device,
  - Use of available anti-static protection products.
- When vacuuming very fine particles, it may occur to clog the pores of the dust filter and to reduce the suction power of the device. In this case, the filter must be cleaned / replaced even if the dirt tank is not filled.
- In the case of a larger subject and shutting down the suction line immediately shut off the device. Do not continue to use the appliance until the object has been removed and the inlet and outlet of the suction line have been removed.
- Only use and place the machine on a flat, strong and stable surface.
- Do not place the appliance:
  - to unstable tables or parts of furniture,
  - on an uneven and dirty surface,
  - on the edges of tables or parts of furniture,
  - in the vicinity of containers with water or other liquids.

- Take special care with your own movement when operating and positioning the appliance when vacuuming the stair / stair floor. Do not place the vacuum cleaner on the stairs and the edges of the stairs into an unstable position and above the persons on the stairs.
- Do not expose the device to:
  - direct sunlight, sources of excessive heat,
  - vibration and mechanical stress,
  - polluting chemicals,
  - water and excess moisture,
  - insect,
  - aggressive environmental influences.

There is a risk of serious injury!

There is a risk of damage to equipment or other property damage!

- Loading and detachment of individual parts and accessories (tubes, hoses), clean and carry the device only when the device is switched off and disconnected from the power supply.
- Do not attach the appliance and the power cord with the fork and do not plug it in with a power socket if you have wet hands or a wet power cord or device. Always dry hands, power cord and equipment dry with a dry cloth.

There is a risk of electric shock!

- Make sure that the main switch is set to „OFF“ in the „0“ position before each connection to the mains.
- Do not switch the device on or off by plugging in or pulling out the power cord from the AC socket.
- Always connect the appliance to mains power supply for normal use, then turn on the main power switch. When you have finished using the device, turn off the main switch and then pull the mains cord out of the AC socket.
- Do not use the device if the main switch does not work!
- Do not use or place the appliance in a place where children may freely reach.
- Prevent children from handling the device. The appliance may overwhelm children and cause serious injury to them.
- Mechanical damage (breakage or breakage of parts and covers) of the device can cause serious injury. Do not use the damaged device. There is a risk of serious injury!

There is a risk of damage to equipment or other property damage!

- Do not use or place the appliance near water containers. If the appliance falls into the water, do not remove it! First, pull the power cord plug out of the mains socket and then select the appliance from the water. In such cases take the device for inspection to a specialist service to verify that it is safe and working properly.

There is a risk of electrical short circuit!

There is a risk of electric shock!

- Do not cover the appliance in part. Do not place any objects on the device. Do not load or allow the foreign bodies to enter the holes of the device covers.

- Do not cover the openings of the airflow covers. Air ventilation ensures proper operation, reliable and safe operation of the device.
- The device contains parts of the covers that can be heated during operation and operation. Do not touch the heated covers of the device!
- Transfer the device only with the handle specified.
- Before any further handling of the device
  - postponement, resp. storage, always wait for the device to cool completely.
- The appliance and the power cord must not be left unattended when connected to a power supply!
- Never leave the appliance unattended and freely accessible and do not leave it with a freely accessible power cord. Children, inappropriate persons or animals could download the device for the power cord or catch the unplugged power cord.
- Always store the device with a wrapped - wired power cord so that the cord is not freely accessible to children, unaccompanied persons or animals. There is a risk of electric shock! There is a risk of serious injury!
- The electrical socket and power cord must remain easily accessible for safe disconnection of the device from the electrical network.
- Do not use additional extension cables to power the device.
- Protect the power cord from damage.
- Never overload the equipment beyond the limits specified by the technical specifications!
- Observe the operating mode of the device (operating time / action and breaks) according to the operating instructions and use. Regularly clean the device - empty from dirt. Filling the device may result in reduced operating parameters, possible overheating, and subsequent damage.
- If you notice any unusual occurrences (sounds, odors, smoke...), immediately switch off the device and unplug it from the mains. Have the device checked in a specialist service.
- If any safety component / component (mechanical, electrical) is part of the unit, never disable this part / component! If the safety component / component is damaged or not working, do not use the appliance!
- Never underestimate the potential hazards and take extreme caution !!!

## Additional safety warnings

If a stick, tube, or hose is stuck when vacuuming, turn off the device and remove the jamming source. Only then continue vacuuming.

- Do not use near heat sources.
- Disconnect the power cord by pulling on the plug. Never pull on the power cord itself.
- Connect the power cord to the wall socket only when your hands are dry.
- Before vacuuming, remove larger and especially sharp objects from the surface to be cleaned, which may damage the dirt tank.
- Do not pick up any hot objects (cigarettes, carbons, matches, etc.).
- Do not block the ventilation openings on the device.
- Do not vacuum spilled liquids.
- Do not overload the power cord with a vacuum cleaner.

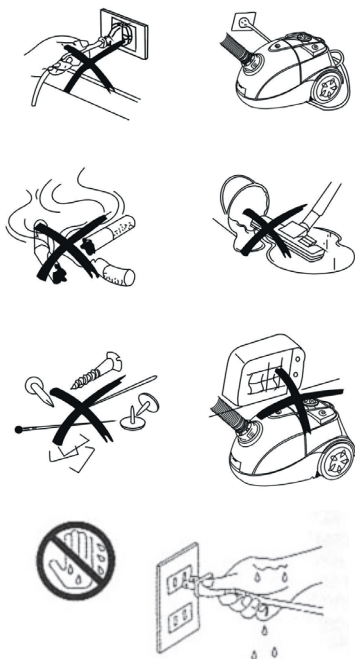

### Note

The device is equipped with an automatically retractable power cord and a winding mechanism. In case of damage to the mains cord or winding mechanism, it is necessary to replace it exclusively by an authorized service center.

### Warning!

Hold the cord lightly with your hand when winding the power cord. Do not allow the cord to wind sharply. The winding mechanism may be damaged.

# Technical specifications

<b>Power supply:</b>	220 - 240 V / 50 Hz
<b>Power input:</b>	700 W
<b>Dimensions (W x D x H):</b>	43,5 x 30,5 x 25 cm
<b>Weight:</b>	4,6 kg
<b>Operating radius/cable length:</b>	9,5/7 m
<b>Suction power:</b>	160 W
<b>Noise level:</b>	72 dB (A)

The declared noise emission value of this appliance is 72 dB (A), which represents the sound power level A relative to the reference sound power of 1 pW.

<b>Package content:</b>	vacuum cleaner (1 pc) metal suction tube (1 pc) floor nozzle with brush (1 pc) suction hose (1 pc) turbo nozzle (1 pc) parquet nozzle (1 pc) grout nozzle (1 pc) furniture nozzle (1 pc) round brush nozzle (1 pc) instruction manual (1 pc)
-------------------------	---

**Subject to change!**

## Preparation

### Power supply

The device operates on AC 230 V, 50 Hz from the mains.

Before using the device, you must connect the device to a power socket using the power cord.

## Parts description

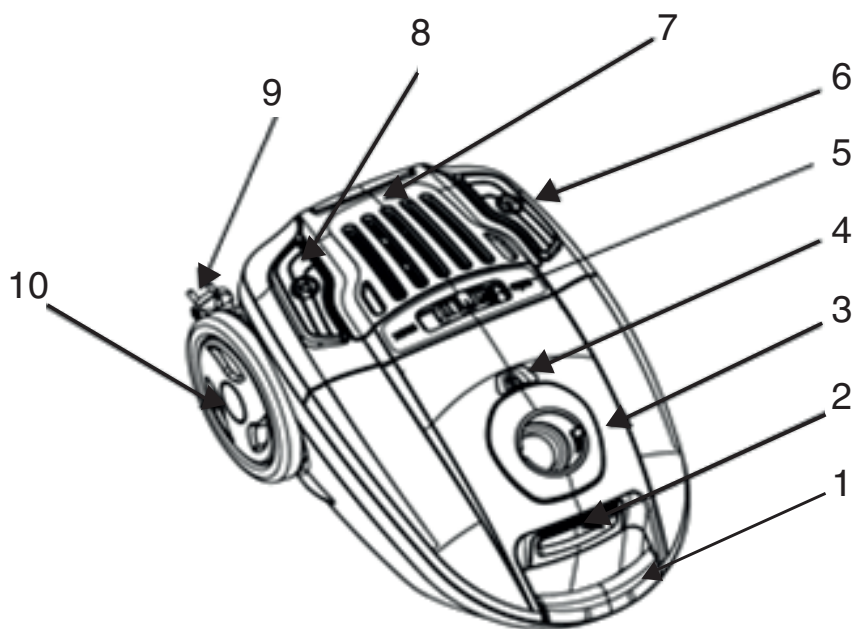

- 1 Cover handle
- 2 Front cover opening locking element
- 3 Suction port
- 4 Full pocket indicator
- 5 Suction power control
- 6 ON/OFF switch
- 7 Blowhole cover
- 8 Power cord winding button
- 9 Power cord
- 10 Wheels

# Assembly and operation

## Before first use

Unpack the device and remove all packing material.

## Vacuum cleaner assembly

Pred nasadzovaním alebo odoberaním príslušenstva odpojte sieťovú šnúru z elektrickej siete.

### 1 Attaching the flexible hose to the vacuum cleaner

Insert the end of the flexible hose into the grooves of the suction opening in the vacuum cleaner and turn it clockwise until it clicks into place.

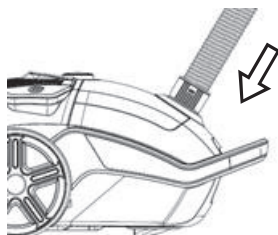

### Removing the hose

Turn the inserted end of the hose counterclockwise and pull the hose out of the suction opening.

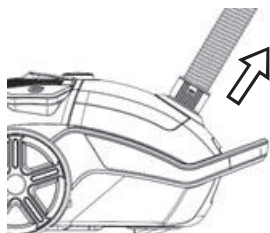

### 2 Insert the metal suction tube into the flexible hose

Place the metal suction tube (as shown below) on the other (bent) end of the flexible hose (handle).



### Suction tube length adjustment

Adjust the length of the suction tube after pressing the locking element on the tube and pull out the extended part of the tube.

### 3 Attaching the suction floor nozzle with a brush (or other accessory) to the suction tube

Attach a floor nozzle (as shown below) or other nozzles to the end of the lower suction tube. Brush on the floor nozzle to push or push in on the surface to be vacuumed by pressing the foot control.

**Other accessories (located in the accessory compartment)**

#### **Crevice nozzle**

Use the crevice nozzle to vacuum radiators, crevices, corners, wall corners and mattress gaps.

#### **Round brush nozzle**

Use a round brush nozzle for vacuuming upholstery or carpet in confined spaces, for vacuuming furniture dust, or a PC keyboard, etc.

#### **Turbobrush**

Use a turbo brush to remove animal hair, hair. You can use it not only at home, but also in the car.

#### **Parquet nozzle**

You can vacuum with it wooden and floating floors, tiles, linoleum, etc.

#### **Furniture nozzle**

You can vacuum furniture and glass with it.



### **With this vacuum cleaner**

#### **Unwinding and winding the power cord**

After attaching the necessary accessories, unwind the required length of the power cord and plug it into the mains.

To wind the cord, press the cord winding button and add additional hands to the cord.



#### **Warning!**

The yellow mark on the power cord indicates the optimum unwinding length of the power cord. Do not remove the power cord for your purpose.

Lose expect to damage winding mechanism.



- 1 Connect the power cord to the wall socket.
- 2 Press the ON/OFF switch to turn on the vacuum cleaner.



- 3 To wind the power cord, press and hold the power cord winding button, and gently hold the power cord by hand while winding the power cord. Do not allow the cord to wind sharply. It could damage the retractor mechanism or cause injury.



### Manual suction power adjustment

The suction power can be adjusted mechanically by the suction intensity control (mechanical) on the handle of the flexible hose.

You can close the opening completely or gradually open it gradually to reduce suction power. For example, vacuuming upholstery requires less suction power than vacuuming rough carpets.

**Opening fully closed:** maximum suction power

**Opening fully opened:** minimum suction power

### Electronic adjustment of suction power

You can adjust the suction power electronically using the suction power control.

You can adjust the suction power step by step. For example, vacuuming upholstery requires less suction power than vacuuming rough carpets.

**Controller in MAX position:** maximum suction power

**Actuator in MIN position:** minimum suction power

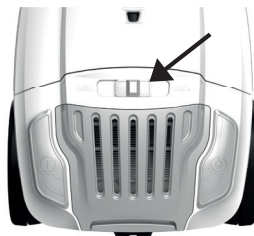

## After vacuuming

- 1 Press the ON / OFF switch on the device to turn off the vacuum cleaner.
- 2 Unplug the power cord.
- 3 Push and hold the cord winding control (also with your foot) and wind the power cord. Hold the cord lightly with your hand when winding the power cord.
- 4 Store the vacuum cleaner and accessories in their place.

## Replacing the dust bag

### Full pocket indicator

The vacuum cleaner is equipped with a full bag indicator. When the bag is full or the tube or hose is blocked, the indicator will turn red. If the suction power decreases significantly, check that the hose is not blocked. Then check that the bag is not full. If so, replace it. We recommend changing the bag when it is full to 2/3 of the volume.



### Warning!

Disconnect the power cord from the wall socket before emptying / replacing the bag to avoid electric shock.

### Note

When vacuuming new or fine-fiber carpets, the bag may fill up faster, so check it more often.

Never vacuum without a dirt bag inserted.

- 1 Squeeze the front cover release lock, open the compartment cover, and remove the pocket holder.

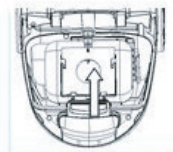

- 2 Remove the old bag by pulling it out. If you use a paper bag, throw the used bag in the trash. Never reuse the old bag.
- 3 Insert the new bag by sliding the bag frame into the bag holder so that the hole in the bag overlaps with the hole in the bag holder.
- 4 Make sure that the bag is correctly inserted. Without the bag and the bag holder properly inserted, the cover cannot be closed.
- 5 Close the front cover.

### **Warning!**

Before closing the cover, make sure that the bag is correctly inserted, that it does not protrude from the compartment and that it does not prevent the cover from closing properly.

## **Filter cleaning and replacement**

The filter must be cleaned or replaced regularly, depending on the intensity of use. Failure to do so may result in reduced device performance and / or reduced filter life.

### **Cleaning/Replacing the exhaust and filter before motor (front filter)**

The exhaust filter is located at the rear of the vacuum cleaner and the motor protection filter (front filter) is in the rear of the dirt bag compartment. Filters must be cleaned / replaced if soiled.

Always use the vacuum cleaner with the filters in place.

Before replacing the filter (s), unplug the power cord from the wall socket to prevent electric shock.

#### **Motor protection filter (front filter)**

- 1 Open the front cover, remove the dirt bag.
- 2 Pull out the filter, clean the filter with warm water and dry it thoroughly, or replace the filter with a new one.
- 3 Reinstall the cleaned/new filter, insert the dirt bag, and close the cover.

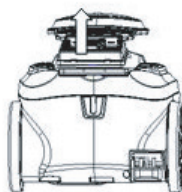

## Exhaust Filter (HEPA)

- 1 Open the top grill.
- 2 Select the filter system.
- 3 Remove the HEPA filter from the system, clean the filter with lukewarm water and dry it thoroughly, or replace the filter with a new one.
- 4 Reinsert the cleaned / new filter and replace the grille.

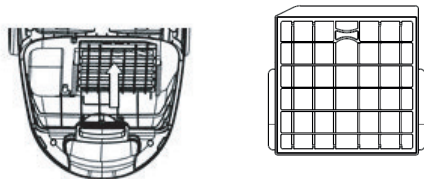

## Warning!

Never insert a wet filter into the vacuum cleaner as this may damage the vacuum cleaner or cause an electric shock.

## Cleaning the suction opening

If there is an object clogging the suction opening of the vacuum cleaner, proceed as follows:

- 1 Pull out the hose.
- 2 Remove the sucked obstruction from the suction port.
- 3 Attach the hose.

## Cleaning and maintenance

- Unplug the power cord. Never wash the device under running water or immerse it in water.
- Clean the device and accessories with a soft cloth.  
Do not use solvents, thinners, alcohol, or abrasive cleaners for cleaning.
- The device must remain completely dry after cleaning.

## Motor thermal fuse

The device is equipped with a thermal fuse against overloading and overheating. This can happen if the hose, tube or nozzles are blocked. If the device turns itself off in the middle of operation, turn it off and wait at least 45 minutes for the engine to cool. Then remove any possible cause of blockage of the hose, tube or nozzle, replace the bag and clean the filters.

After the engine has cooled down, switch the device on again.

If the device still does not work properly, contact the service center.

## Troubleshooting

<b>Problem</b>	<b>Possible cause</b>	<b>Recommendation</b>
The vacuum cleaner will not switch on	<ul style="list-style-type: none"><li>- the power cord is not plugged in properly and securely into the wall outlet</li><li>- the power socket is damaged</li></ul>	<ul style="list-style-type: none"><li>- plug the plug firmly into the mains socket</li><li>- check the power socket</li></ul>
The suction power is weak	<ul style="list-style-type: none"><li>- device/hose is clogged</li><li>- the dust filter is dirty</li><li>- the filter is clogged</li></ul>	<ul style="list-style-type: none"><li>- remove the clogged material</li><li>- clean the dust filter</li><li>- clean the filter</li></ul>
The cable will not be reeled	the cable could jam during the winding	when wiring the cable, hold the cable slightly tightened
Power control does not work	the device is broken	ensure equipment repair (service)

**Producer:**

ORAVA retail 1, a.s.  
Seberínho 2  
821 03 Bratislava  
Slovenská republika

**Importer:**

ORAVA retail 1, a.s. Seberínho 2 821 03 Bratislava Slovenská republika	ORAVA distribution CZ, s.r.o. Ostravská 494 739 25 Sviadnov Česká republika
---	--

**INSTRUCTIONS AND INFORMATION REGARDING THE DISPOSAL OF USED PACKAGING**

Dispose of used packaging material at a municipal waste disposal site.

**DISPOSAL OF USED ELECTRICAL AND ELECTRONIC EQUIPMENT**

This symbol on the products or in the accompanying documents means that used electrical and electronic products should not be mixed with general household waste. For proper disposal, recovery and recycling, please return these products to designated collection points. Alternatively, in some countries of the European Union or other European countries, you may return your products to your local retailer when purchasing an equivalent new product. By ensuring this product is disposed of correctly, you will help prevent potential negative consequences for the environment natural resources and help prevent potential negative effects on environment and human health, which could be the consequences of improper disposal waste. Contact your local authority or nearest office for more details collection point. Improper disposal of this type of waste may result in penalties in accordance with national regulations.

**For business entities in the countries of the European Union**

If you wish to discard electrical and electronic equipment, please request the necessary information from your seller or supplier.

**Disposal in other countries outside the European Union**

This symbol is valid in the European Union. If you wish to discard this product, please request obtain the necessary information on the correct method of disposal from the local authorities or from the your supplier.



This product complies with all the essential requirements of the EU directives that apply to it.